



## **PAGASYS Series Loudspeaker Models P-LS2B and P-LS2C**



---

### *Installation, Operation, and Maintenance Instructions*



**Warranty** – Seller warrants all goods for five years on parts and 2-1/2 years on labor, under the following conditions and exceptions: Seller warrants that all goods of Seller's manufacture will conform to any descriptions thereof for specifications which are expressly made a part of this sales contract and at the time of sale by Seller such goods shall be commercially free from defects in material or workmanship. Seller reserves the right at the Seller's discretion to "Repair and Return" or "Replace" any item deemed defective during the warranty period. This warranty does not cover travel expenses, the cost of specialized equipment for gaining access to the product, or labor charges for removal and reinstallation of the product. This warranty shall be ineffective and shall not apply to goods that have been subjected to misuse, neglect, accident, damage, improper maintenance, or to goods altered or repaired by anyone other than Seller or its authorized representative, or if five years have elapsed from the date of shipment of the goods by Seller with the following exceptions: lamps and strobe tubes are not covered under this warranty. Outdoor warning sirens and controllers manufactured by Federal Warning Systems are warranted for two years on parts and one year on labor. No agent, employee, representative or distributor of Seller has any authority to bind the Seller to any representation, affirmation, or warranty concerning the goods and any such representation, affirmation or warranty shall not be deemed to have become a part of the basics of the sales contract and shall be unenforceable. THE FOREGOING WARRANTIES ARE EXCLUSIVE AND IN LIEU OF ALL OTHER WARRANTIES OR MERCHANTABILITY, FITNESS FOR PURPOSE AND OF ANY OTHER TYPE, WHETHER EXPRESS OR IMPLIED. These warranties shall not apply unless Seller shall be given reasonable opportunity to investigate all claims for allegedly defective goods. Upon Seller's instruction a sample only of allegedly defective goods shall be returned to Seller for its inspection and approval. The basis of all claims for alleged defects in the goods not discoverable upon reasonable inspection thereof pursuant to paragraph 8 hereof must be fully explained in writing and received by Seller within thirty days after Buyer learns of the defect or such claim shall be deemed waived.



2645 Federal Signal Drive • University Park • IL 60484-3167  
Tel: +1 708-534-4723 • Fax: +1 708-534-4887  
systems@fedsig.com • www.fs-isys.com

## Contents

Safety Messages to Installers, Users, and Maintenance Personnel.....	5
Unpacking the Loudspeaker.....	6
Overview of the PAGASYS Series.....	6
Certifications.....	7
Specifications .....	7
Special Conditions for Safe Use .....	8
Mounting the Loudspeaker .....	8
Adjusting the Vertical Angle.....	9
Wiring the Loudspeaker.....	9
Setting Transformer Wattage Taps .....	11
Completing the Installation .....	11
Safety Messages to Maintenance Personnel .....	13
Periodically Inspecting the Loudspeaker .....	14
Servicing the Loudspeaker.....	14
Returning a Product for Credit.....	15
Getting Technical Service and Support .....	15
Ordering Replacement Parts.....	16

## Figures

Figure 1 Loudspeaker connections .....	10
Figure 2 Internal wiring.....	12

## Tables

<b>Table 1</b> Wattage tap settings .....	11
<b>Table 2</b> Example serial number.....	16
<b>Table 3</b> Replacement parts .....	16

## **Safety Messages to Installers, Users, and Maintenance Personnel**

It is important to follow all instructions shipped with this loudspeaker. This loudspeaker is to be installed by trained personnel who is thoroughly familiar with the country electric codes and will follow these guidelines as well as local codes.

The selection of the mounting location for the device, its controls and the routing of the wiring is to be done under the direction of the facilities engineer and the safety engineer. In addition, listed below are some other important safety instructions and precautions you should follow:

- Read and understand all instructions before installing or operating this equipment.
- Disconnect the device from the power supply/audio source before any installation or maintenance is performed.
- Do not open the loudspeaker enclosure when a hazardous atmosphere is present.
- To determine if the device can be used safely in the intended area, review the certifications section on page 7.
- All effective warning loudspeakers produce loud sounds, which may cause, in certain situations, permanent hearing loss. Take appropriate precautions such as hearing protection.
- All effective warning loudspeakers produce loud sounds, which may cause, in certain situations, permanent hearing loss. The device should be installed far enough away from potential listeners to limit their exposure while still maintaining its effectiveness.
- After installation, test the loudspeaker to ensure that it is operating properly. After testing is complete, provide a copy of this instruction booklet to all operating personnel.
- Establish a procedure to routinely check the loudspeaker installation for integrity and proper operation.
- The product nameplate, which may contain cautionary or other information of importance to maintenance personnel, should not be obscured in any way.

Failure to follow all safety precautions and instructions may result in property damage, serious injury, or death.

## **Unpacking the Loudspeaker**

After unpacking the loudspeaker, examine it for damage that may have occurred in transit. If the loudspeaker has been damaged, do not attempt to install or operate it. File a claim immediately with the carrier stating the extent of the damage. If you are missing any parts, contact Customer Support at +1 708-534-4756. Carefully check all envelopes, shipping labels, and tags before removing or destroying them.

## **Overview of the PAGASYS Series**

The Federal Signal PAGASYS Non-Metallic Loudspeakers, Models P-LS2B and P-LS2C, are designed for use in industrial public address and general alarm applications where corrosion resistance and ATEX/IEC certification are required. PAGASYS loudspeakers are available in an ATEX/IEC Zone 1 explosion-proof version certified for ingress of dust and combustible gas to either Group IIB or Group IIC.

PAGASYS loudspeakers are manufactured from corrosion-resistant, anti-static, glass-reinforced polyester (GRP). The total power output capability is 25 W, adjustable down to 0.2 W. The available audio input is 100 Vrms.



The mounting bracket included with the loudspeaker is stainless steel with two standard mounting holes and a hole for the cable. The bracket is ratcheted to lock the loudspeaker at a specific vertical angle. Also available is a stainless steel ratcheted bracket with four additional mounting holes that are slotted to allow the loudspeaker to be aimed horizontally.

## Certifications

ATEX Certificate Number: Baseefa10ATEX0096X

IECEX Certificate Number: IECEX BAS 10.0052X



### Model P-LS2B

  II 2G

EX d e mb IIB + H2 T5 Gb ( $-50\text{ °C} \leq T_a \leq +70\text{ °C}$ )

T6 Gb ( $-50\text{ °C} \leq T_a \leq +70\text{ °C}$ )

### Model P-LS2C

  II 2GD

EX d e mb IIC T5 Gb Ex tb IIIC IP66 T100 °C Db  
( $-50\text{ °C} \leq T_a \leq +70\text{ °C}$ )

T6 Gb Ex tb IIIC IP66 T85 °C Db  
( $-50\text{ °C} \leq T_a \leq +55\text{ °C}$ )

Where:  indicates compliance with directive 94/9/EC

 hexagon symbol, the specific marking of explosion protection

- II indicates suitability for use in surface industries
- 2 indicates suitability for use in a Zone 1 area
- G indicates suitability for use in the presence of gases
- D indicates suitability for use in the presence of combustible dusts

## Specifications

**Electrical:** Audio Line Voltage: 100 Vrms  
Max. Rated Power: 25 W

**Ambient Environment:** T5:  $-50\text{ °C} \leq T_a \leq +70\text{ °C}$   
T6:  $-50\text{ °C} \leq T_a \leq +55\text{ °C}$   
Pa = 80 kPa to 110 kPa

**Max. Surface Temperature:** 85 °C at +55 °C ambient  
100 °C at +70 °C ambient

**Enclosure Rating:** IP66  
Indoor/Outdoor Use

**Gland Entries:** 2 x M20 x 1.5 mm

**Cable Terminations:** 0.5 mm<sup>2</sup> to 4 mm<sup>2</sup> (22 AWG to 12 AWG)  
to

**Size (P-LS2B and P-LS2C):** Diameter: 232.4 mm (9.15 in)  
Height: 286.2 mm (11.27 in)  
Length: 318.8 mm (12.55 in)

**Material:** Glass-Reinforced Polyester (GRP)

**Color:** Black

**Audio Input:** 100 Vrms

**Net Weight  
(PLS2B and P-LS2C):** 5.9 kg (13.0 lb)

**Shipping Weight  
(PLS2B and P-LS2C):** 6.9 kg (15.3 lb)

## Special Conditions for Safe Use

- Not more than one single- or multiple-stranded lead shall be connected into either side of any terminal, unless multiple conductors have been joined in a suitable manner, e.g., two conductors into a single insulated crimped boot-lace ferrule.
- Leads connected to terminals shall be insulated for the appropriate voltage, and this insulation shall extend to within 1 mm (0.04 in) of the metal of the terminal throat.
- All terminal screws, used and unused, shall be tightened down to between 0.5 N·m to 0.7 N·m (4.4 in-lb to 6.2 in-lb).

## Mounting the Loudspeaker

### NOTICE

#### DRILLING PRECAUTIONS

***When drilling holes, check the area into which you are drilling to be sure you do not damage anything while drilling. All drilled holes should be de-burred and all sharp edges should be smoothed.***

The Models P-LS2B and P-LS2C loudspeakers are designed for mounting on a flat horizontal or vertical surface.

To mount the loudspeaker, obtain M6 stainless steel bolts, lockwashers, and flat washers.



**IMPORTANT:** The nameplate, which contains cautionary or other information of importance to maintenance personnel, should not be obscured.

1. Select a mounting location that is capable of supporting more than 6 kg (13.2 lb).
2. Use the mounting bracket as a template to scribe the centers of the mounting holes.
3. Drill an appropriately sized hole at each scribed mark for the mounting screws.
4. Mount the bracket with the installer-supplied M6 hardware.
5. Secure the loudspeaker to the mounting bracket.

## Adjusting the Vertical Angle

To adjust the vertical angle of the loudspeaker:

1. Loosen the fasteners on the mounting bracket to disengage the ratchet.
2. Vertically aim the loudspeaker.
3. Hold the loudspeaker in place while tightening the fasteners on the bracket.

## Wiring the Loudspeaker

### **WARNING**

#### **SHOCK HAZARD**

**To avoid an electrical shock, do not connect the loudspeaker to the system while the power is on. Failure to heed this warning may cause serious injury or death.**

Two M20 threaded entries are provided in the side of the rear cover for the installation of certified Ex d or Ex e cable glands. All unused entries must be sealed with a suitably rated stopper plug.

A terminal block with twelve-pole screws is provided for field wiring (Figure 1 on page 10 and Figure 2 on page 12). The terminals are rated for the range of 0.5 mm<sup>2</sup> to 4 mm<sup>2</sup> (22 AWG to 12 AWG).

Tighten the terminal screws to a torque of 0.5 N·m to 0.7 N·m (4.4 in-lb to 6.2 in-lb).

To wire the loudspeaker:

1. Loosen the four screws securing the rear cover to the loudspeaker, and remove the cover.
2. Route the lead from the audio input to the terminal marked +IN.
3. Route the lead from the amplifier to the terminal marked -IN.

The +OUT/-OUT terminals may be used to connect to an additional speaker, if required. Loudspeakers in close proximity must be connected in phase.

**Figure 1** Loudspeaker connections

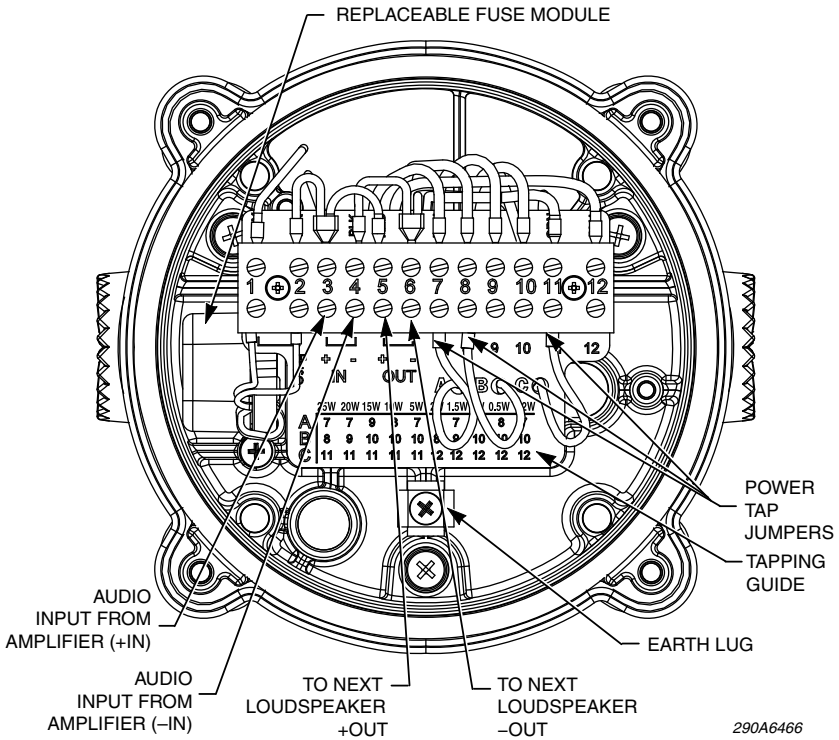

## Setting Transformer Wattage Taps

The Model P-LS2B and P-LS2C loudspeakers have ten wattage tap settings that enable you to select the loudness of each loudspeaker in the system (see Table 1 below and Figure 2 on page 12). The higher the wattage tap, the louder the speaker output. Tighten the terminal screws to a torque of 0.5 N·m to 0.7 N·m (4.4 in-lb to 6.2 in-lb).

**Table 1** Wattage tap settings

<b>Terminal A</b>	<b>Terminal B</b>	<b>Terminal C</b>	<b>Tap</b>
7	8	11	25 W
7	9	11	20 W
9	10	11	15 W
8	10	11	10 W
7	10	11	5 W
7	8	12	2 W
7	9	12	1.5 W
9	10	12	1 W
8	10	12	0.5 W
7	10	12	0.2 W

## Completing the Installation

To complete the installation of the loudspeaker system:

1. Make sure that the gasket is properly seated
2. Replace the rear cover and tighten the screws securing it to approximately 4 N·m (35.4 in-lb).
3. Test the speaker system to verify that it operates properly.

**Figure 2** Internal wiring

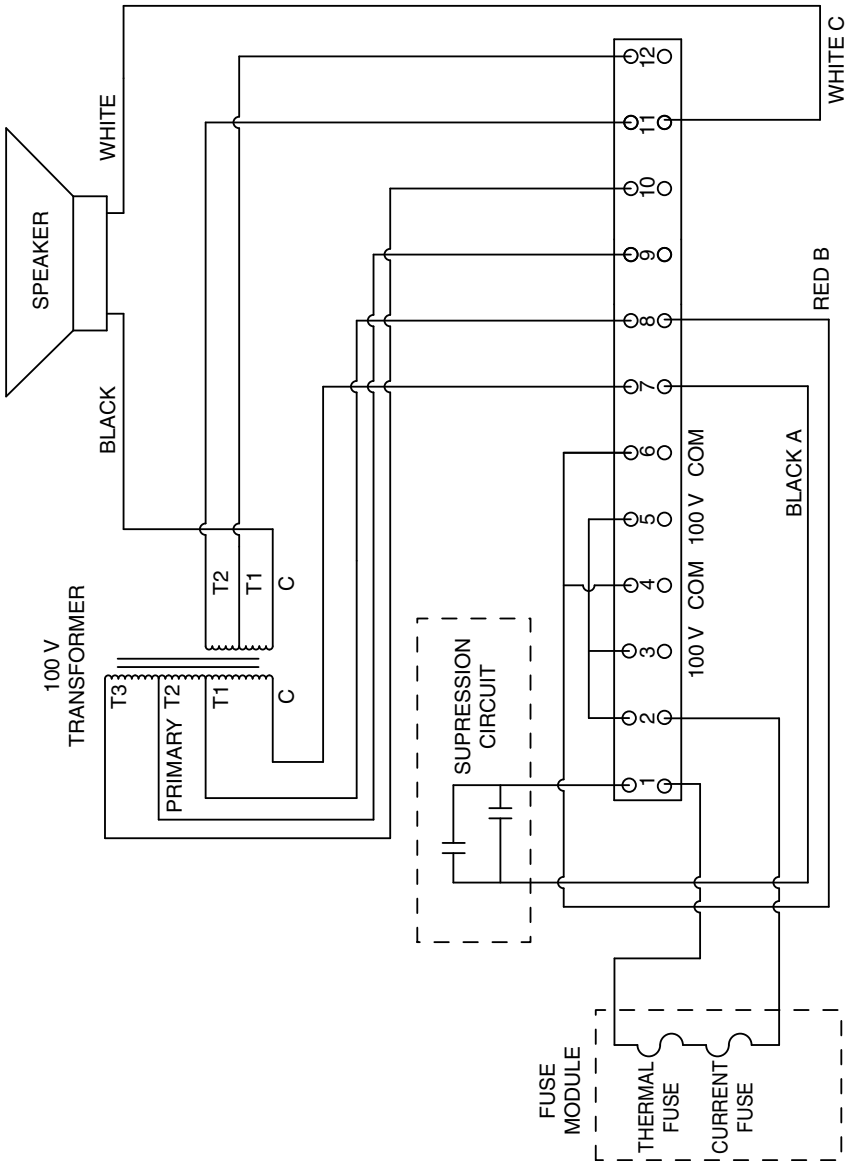

## Safety Messages to Maintenance Personnel

### **WARNING**

#### **FIRE/EXPLOSION HAZARD**

**Do not open the loudspeaker when it is energized. Failure to observe this warning could result in serious injury or death.**

Listed below are some important safety instructions and precautions you should follow:

- Any maintenance to the loudspeaker must be performed by properly trained personnel.
- Read and understand all instructions before maintaining and operating this loudspeaker.
- Any maintenance to the loudspeaker must be done with the power turned off.
- After disconnecting power, allow ten minutes for the internal components to cool and to allow all capacitors to discharge.
- Do not open the loudspeaker enclosure when a hazardous atmosphere is present.
- Never alter the loudspeaker in any manner. Safety may be endangered if additional openings or other alterations are made to the loudspeaker.
- Use only service parts provided by the Federal Signal factory. Only these components have been verified and certified for use in hazardous areas.
- Any repairs or modifications made to the flameproof driver or encapsulated areas will invalidate the certification.
- The nameplate, which contains cautionary or other information of importance to maintenance personnel, should not be obscured.
- After performing any maintenance, test the unit to ensure that it is operating properly.

## Periodically Inspecting the Loudspeaker

Establishing a regular inspection schedule for the loudspeaker extends the life of the loudspeaker and ensures safety. For a list of replacement parts see page 16.

- ✓ Ensure that the the loudspeaker is maintained in line with the regulations in force and at regular intervals, at least once per year.
- ✓ Check for external damage and repair and replace as necessary.
- ✓ Check that the gasket is seated properly and that it is not brittle or damaged.
- ✓ Periodic checks should be made to ensure that the effectiveness of this device has not been reduced because the speaker has become clogged with a foreign substance or because objects have been placed in front of the speaker.
- ✓ Check all earth connections.
- ✓ Check for water/dust ingress and replace seals as necessary.

## Servicing the Loudspeaker

### **WARNING**

#### **SHOCK HAZARD**

**To avoid an electrical shock, do not connect the loudspeaker to the system while the power is on.**

The loudspeaker is fully encapsulated and the speaker driver is non-serviceable. If the driver fails, the entire loudspeaker must be replaced. If it does not operate, verify continuity of the fuse module before replacing the loudspeaker (Figure 2 on page 12). The fuse module, which contains a thermal fuse and a current fuse, is a replaceable part. For ordering information, see page 16.

To replace the fuse:

1. Turn off power to the loudspeaker.
2. Remove the four screws securing the rear cover to the loudspeaker, and remove the cover.
3. Disconnect the leads of the fuse module from the terminal block.

4. Remove the Phillips-head screw securing the fuse module, and remove the module.
5. Reinstall the new fuse module.
6. Replace the rear cover and tighten the screws securing it to approximately 4 N·m (35.4 in-lb).
7. Test the speaker system to verify that it operates properly.

## **Returning a Product for Credit**

Product returns for credit require a return authorization from your local distributor prior to returning the product to Federal Signal. Please contact your distributor for assistance.

A product is qualified to be returned for credit when the following conditions are met:

- Product is resalable and in the original cartons
- Product has not been previously installed
- Product is the current revision
- Product has not been previously repaired
- Product is a standard product
- Product is not a service part

All returns are subject to a re-stock fee.

Defective products that are returned within the warranty period will be repaired or replaced at Federal Signal's sole discretion. Defective products do not include those products with lamp failure.

Circumstances other than those listed above will be addressed on a case-by-case basis.

## **Getting Technical Service and Support**

Products returned for repair require a Return Authorization form. To obtain service for the product, please contact the Federal Signal Service Department at +1 708-534-4858.

For technical assistance, please call Federal Signal Technical Support at +1 708-534-3424, extension 5823.

To expedite service, please see to the loudspeaker label for the model and serial numbers. For an interpretation of the information coded into an example of a serial number, see Table 2.

**Table 2** Example serial number

LS0916400000      LS = Factory product code  
                                  09 = Last two digits of the year of manufacture  
                                  164 = Numerical day code of manufacture  
                                  00000 = Five-digit code for product serial number

## Ordering Replacement Parts

To order replacement parts in Table 3, please call Federal Signal Customer Support at +1 708-534-4756.

**Table 3** Replacement parts

<b>Description</b>	<b>Part Number</b>
Mounting Bracket	K8595171
Mounting Bracket with slots	K8595172
Ratchet Fixing Kit	K8595194
Bracket Mounting Screws	K7002086-16
Outer Horn	K8595150
Rear Cover	K8595153
Rear Cover Gasket Kit	K8595195
Fuse Module	K8595177

